

System description

**Test Setup for MIL-STD-461 D, E&F
 CS114 + CS115 + CS116 (and CS106)**



1.	TEST SETUP DESCRIPTION.....	2
1.1	TEST SETUP	2
1.2	CALIBRATION SETUP	3
1.3	INJECTED PERTURBATIONS.....	3
2.	CS 116 DAMPED SINUSOIDAL PULSE GENERATOR.....	6
3.	TEST EQUIPMENT FOR CS114 +CS115 + CS116 TESTS	9
4.	OPTIONAL EQUIPMENT FOR CS106.....	10
5.	CONTROL INTERFACE FOR FULLY AUTOMATED SYSTEM	12
6.	ACCESSORIES.....	16
6.1	INJECTION PROBES WITH CALIBRATION JIG.....	16
6.2	LISN.....	16
7.	SERVICES.....	16
7.1	ONSITE INSTALLATION AND TRAINING	16
7.2	MAINTENANCE	16
8.	TECHNICAL SPECIFICATIONS.....	17
9.	MONTENA.....	18

Version 5.1/ 1.10.2012

C:\Users\bdaout.MONTENA\Documents_Transfert\System_description_CS114_115_116_Test_Setup_V51.doc

1. Test setup description

1.1 Test setup

montena's fully automated test setup for MIL-STD 461, CS 114 + 115 + 116 comprises following elements:

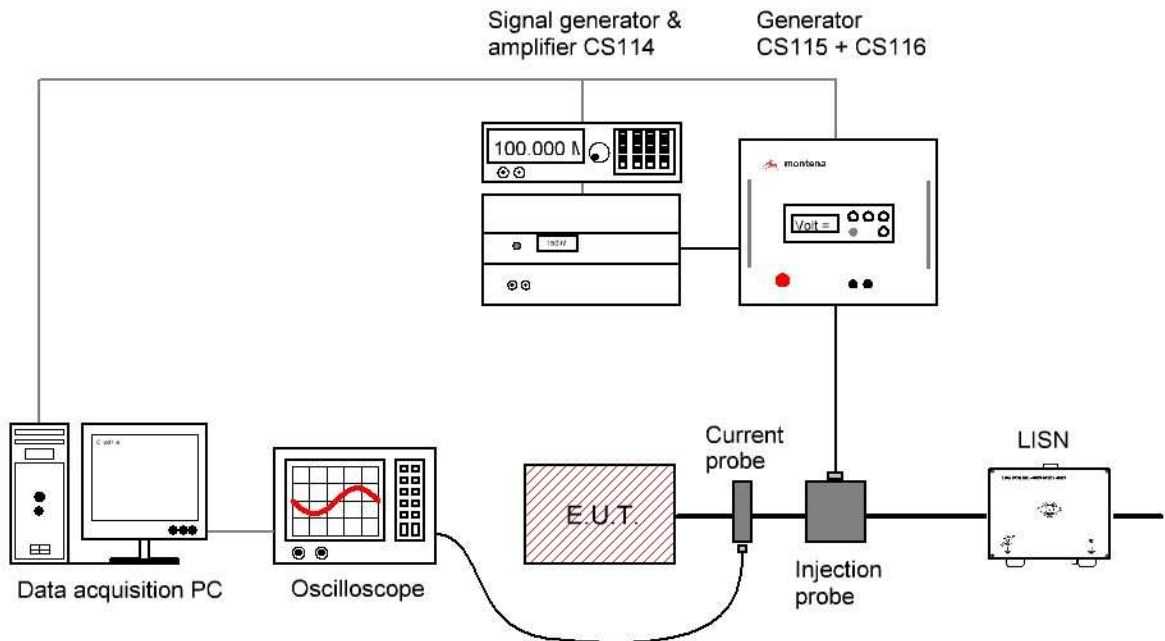

Figure 1 : Combined test setup for CS114, CS115 & CS116

The test generator is connected to the current injection probe. The generator has one single output for CS115 and CS116 signals. It additionally has an input to receive the CS114 CW signal from the amplifier and drives it directly to the injection probe too.

An oscilloscope connected to a current probe checks the level of the injected perturbation. LISN are to be used to control the impedance on the power line.

A PC with a dedicated control software application allows fully automatic calibration and test sequences, as well as the automatic generation of test reports.

One single signal output

Thanks to the HF switching capability integrated inside the pulse generator, the whole calibration or the measurement phase can be performed for the 3 tests without any need to change the cabling, considerably reducing the calibration and measurement time, as well as reducing to almost zero the risk of errors due to human mistakes.

1.2 Calibration setup

The figure below shows the same setup in the calibration configuration.

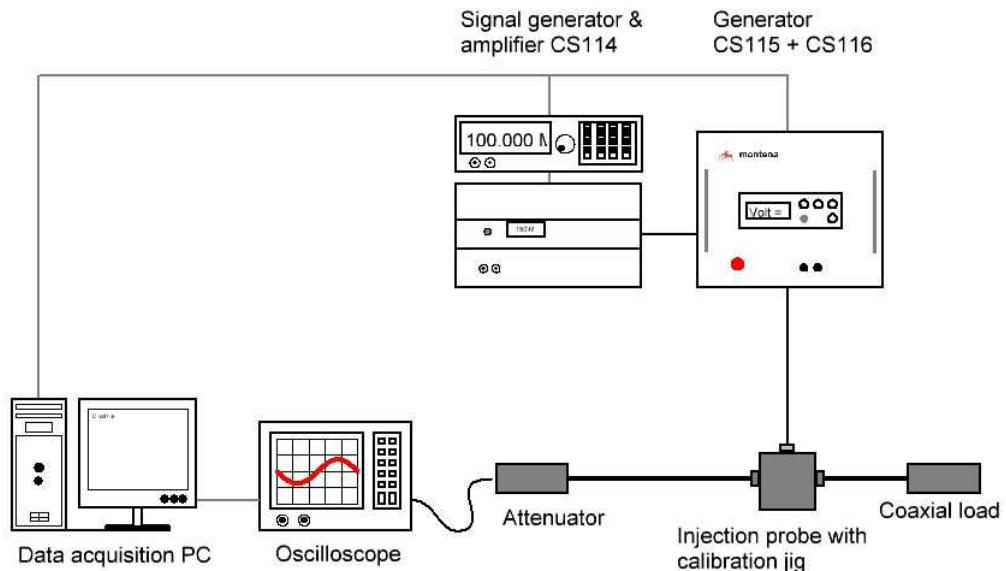

Figure 2 : schematic of a CS 114 + 115 + 116 calibration setup

1.3 Injected perturbations

CS114 injected signal and level

CS 114 test system delivers the CW signal according to MIL-STD 461 D, E and F versions.

In the control software the user can select the test signal level based on the defined curves and table taken from the standards.

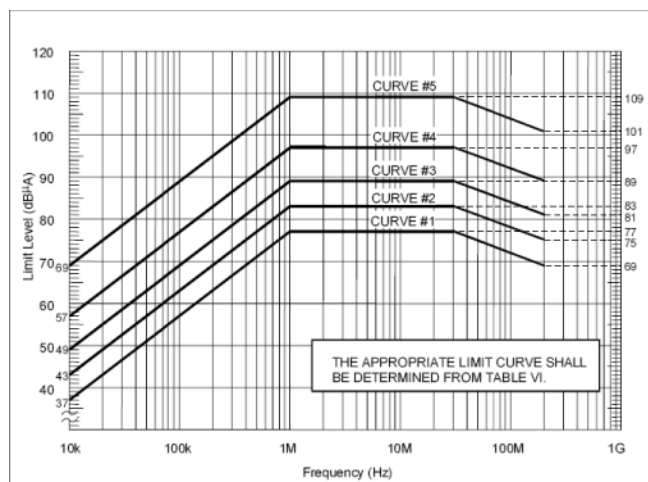

In the automatic mode (software controlled) the system calibration will automatically determine the required generator's output level to obtain the specified current injection level.

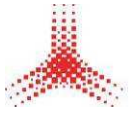

CS115 pulse shape and level

CS 115 test system delivers a square pulse according to MIL-STD 461 D, E and F versions.

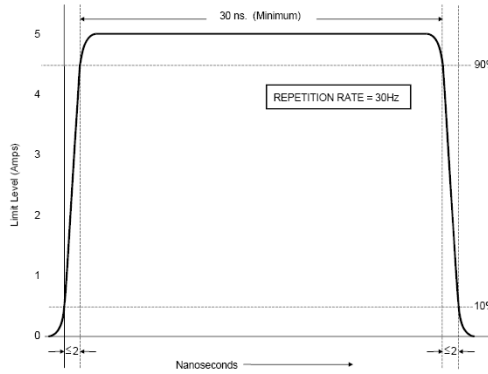
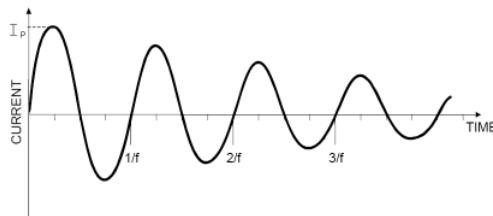

Figure 3 : MIL-STD-461 D, E&F CS115 pulse shape

In the automatic mode (software controlled) the current injection level can be defined and the system calibration will automatically determine the required generator's output level to obtain the specified current injection level.

CS116 pulse shape and level

CS 116 test system delivers a damped sinusoidal pulse according to MIL-STD 461 D, E and F versions.



NOTES: 1. Normalized waveform: $e^{-(\pi f t)/Q} \sin(2\pi f t)$
 Where:
 f = Frequency (Hz)
 t = Time (sec)
 Q = Damping factor, 15 ± 5

2. Damping factor (Q) shall be determined as follows:

$$Q = \frac{\pi(N - 1)}{\ln(I_p/I_N)}$$

Where:

Q = Damping factor

N = Cycle number (i.e. $N = 2, 3, 4, 5, \dots$)

I_p = Peak current at 1st cycle

I_N = Peak current at cycle closest to 50% decay

\ln = Natural log

3. I_p as specified in Figure CS116-2

Figure 4 : MIL-STD-461 D, E&F CS116 pulse shape

The damped sinusoidal pulse level can be manually tuned to obtain the required current injection level.

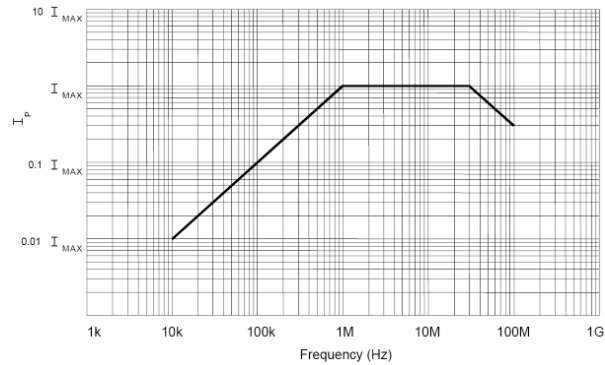
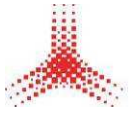

Note: in the MIL-STD 461 D&E versions, two levels are defined with

1. For Army and Navy procurements, $I_{MAX} = 10$ amperes
2. For Air Force procurements, $I_{MAX} = 5$ amperes

Figure 5 : MIL-STD-461 D, E&F CS116 pulse current level

In the automatic mode (software controlled) the current injection level can be defined for each available discrete frequency and the system calibration will automatically determine the required generator's output level to obtain the specified current injection level.

2. CS 116 damped sinusoidal pulse generator

The damped sinusoidal generator POG-CS116 xF can be supplied with 6 to 17 discrete frequencies.

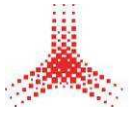

Figure 6: Montena pulse generator for CS 116

Menu driven control panel

The menu driven control panel allows the user to select the desired discrete frequency, the pulse voltage level, the repetition rate and the number of pulse to be generated.

> Volt. = 070.0%	Voltage in % of maximum level
Freq. = 1MHz	Frequency
Rate = 0.5Hz	Repetition rate
Nbr = 019/600 L	Number of pulses (current count/fixed number)



From 6 to 17 frequencies

The MIL STD 461 D, E & F CS116 requires testing the susceptibility at 6 discrete frequencies between 10 kHz and 100 MHz.

Montena's CS116 generator provides additional frequencies too:

Oscillation frequency	Maximal current ¹⁾	PDG116 - 6F	PDG116 - 9F	PDG116 - 17F
10 kHz	0.1 A	X	X	X
18 kHz ²⁾	0.2 A			X
30 kHz ²⁾	0.3 A		X	X
56 kHz ²⁾	0.6 A			X
100 kHz	1 A	X	X	X
180 kHz ²⁾	2 A			X
300 kHz ²⁾	3 A		X	X
560 kHz ²⁾	6 A			X
1 MHz	10 A	X	X	X
1.8 MHz ²⁾	10 A			X
3 MHz ²⁾	10 A		X	X
5.6 MHz ²⁾	10 A			X
10 MHz	10 A	X	X	X
18 MHz ²⁾	10 A			X
30 MHz	10 A	X	X	X
56 MHz ²⁾	5.5 A			X
100 MHz	3 A	X	X	X

¹⁾ At 100 % voltage setting and with a 2 m 50 Ω coaxial cable, with the dedicated injection probe (e.g. Prâna IP-DR250) and calibration jig, on the 100 ohm calibration load.

²⁾ These frequencies are not required by the MIL STD 461 but we recommend them to have a better coverage of the frequency range.

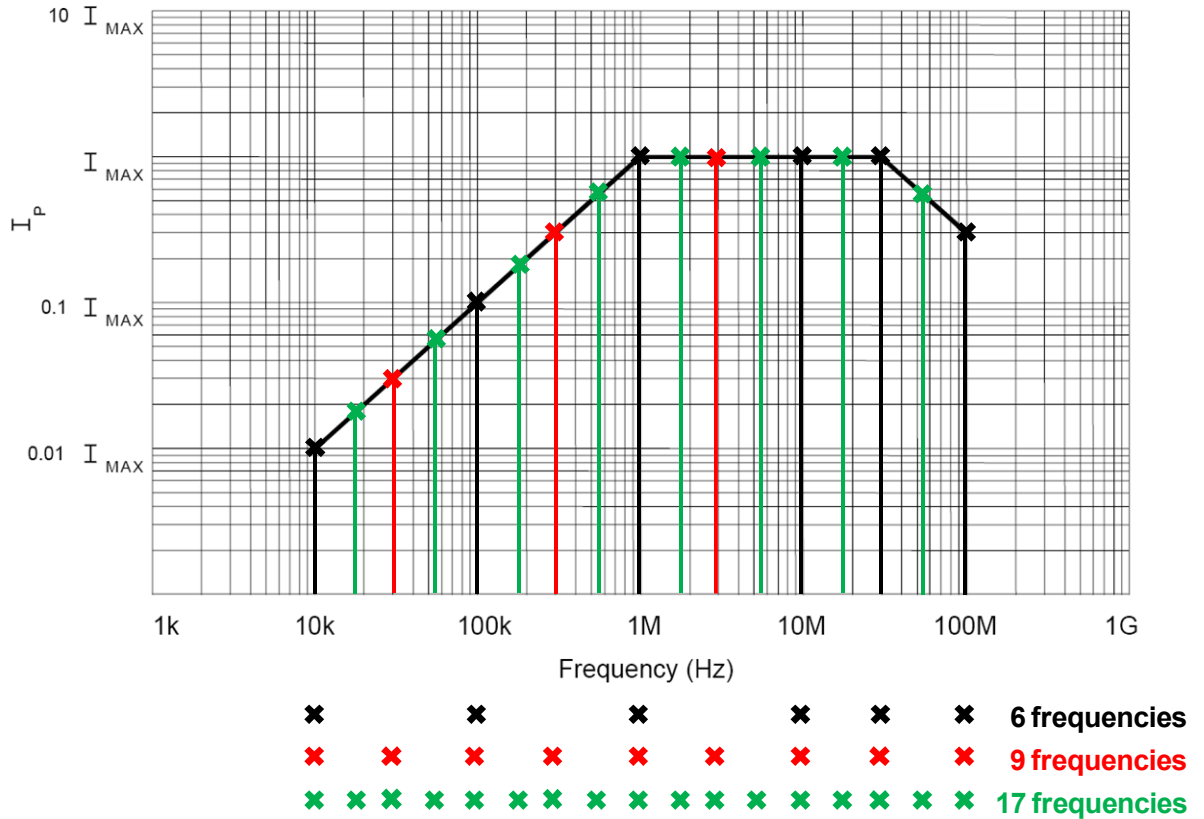
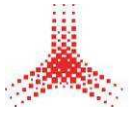

Figure 7: Available CS116 test frequencies

In the 9 or 17 frequencies version, the test frequencies are evenly distributed between 10kHz and 100MHz for better coverage of potential system resonances.

In some cases it is very interesting to be able to test the susceptibility of the equipment with some in-between frequencies which will be present in the real deployment and will threaten the equipment's performances.

Optionally montena can provides some additional discrete frequencies anywhere in the range comprised between 10 kHz and 100 MHz.

3. Test equipment for CS114 +CS115 + CS116 tests

The proposed test setup is made of:

Pos.	Item	Qty
1	<i>Pulse generator CS116 – one of the below option</i>	
1.1	Montena POG-CS116-6 Pulse generator for MIL-STD 461 D/E/F CS116, 6 test frequencies, 19" rack version	1
1.2	Montena POG-CS116-9 Pulse generator for MIL-STD 461 D/E/F CS116, 9 test frequencies, 19" rack version	0
1.3	Montena POG-CS116-17 Pulse generator for MIL-STD 461 D/E/F CS116, 17 test frequencies, 19" rack version	0
2	Montena HOUSING-9U Instrument case for standalone use of the POG-CS116 generator, 9HU, 520mm	1
3	<i>Pulse generator CS115 – one of the below option</i>	
3.1	Montena M-CS115 Module for MIL-STD 461 D/E/F CS115, to be inserted in POG-CS116 generator	1
3.2	Montena PG-CS115 Standalone pulse generator for MIL-STD 461 D/E/F CS115, for rack19" or table top use.	0
4	<i>CS114 signal generator and amplifier</i>	
4.1	Signal generator (for CS114 test)	1
4.2	Power amplifier (for CS114 test) 110W, 10kHz - 400 MHz, with control interface and integrated directional coupler	1
5	<i>Injection probe</i>	
5.1	Prâna IPDR-250 Injection probe for MIL STD 461 CS115 and CS116 internal diameter : 43 mm	1
5.2	Prâna CJDR-250 Calibration jig for the injection probe IP-DR250	1
6	<i>Test control & monitoring, and accessories</i>	
6.1	Current probe	1
6.2	50 ohm 100W coaxial load	1
6.3	50 ohm attenuator, 100W (1x20dB, 1x40dB)	2
6.4	400MHz, 2 channels oscilloscope, with FFT	1
6.6	Montena control software package for CS114 + CS115 + CS116	1

4. Optional equipment for CS106

It is possible to extend the system to additionally perform pulse injection test according to CS106 standard.

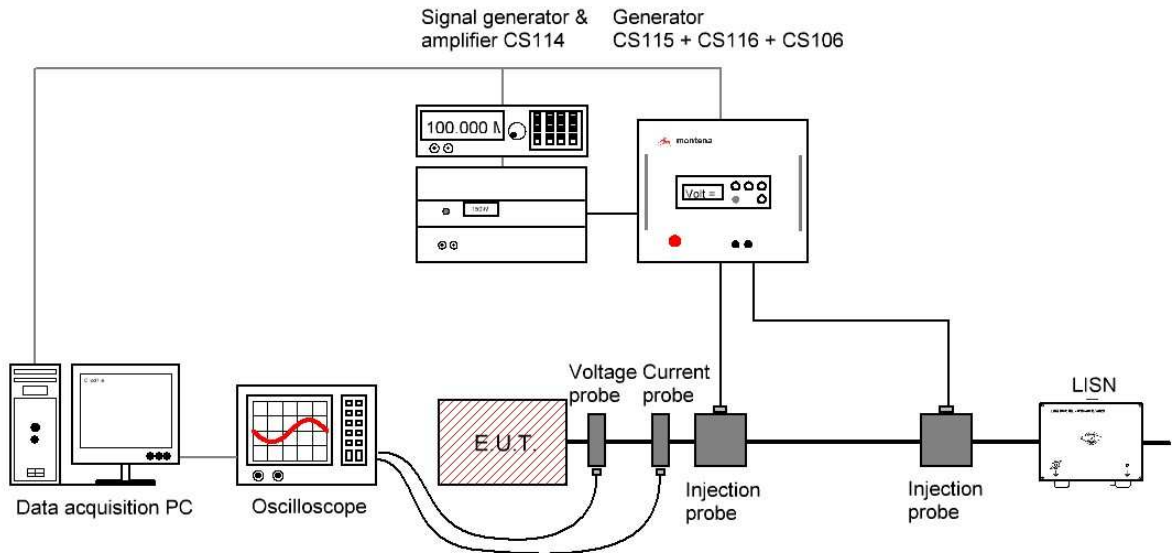
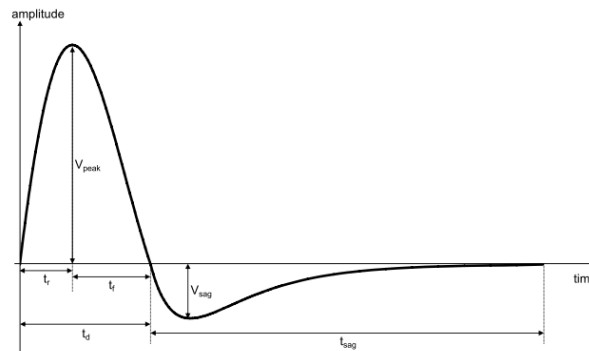

Figure 8 : Combined test setup for CS106, CS114, CS115 & CS116

Because of the low frequency content and high amplitude of the CS016 pulse, it is not possible to use the same injection probe as already utilized for the CS114, CS115 and CS116.

CS106 pulse shape and level

CS 106 test system delivers a pulse according to MIL-STD 461 F version.



Where:

- $V_{peak} = 400$ volt peak
- $t_r = 1.5 \mu\text{sec}, \pm 0.5 \mu\text{sec}$
- $t_f = 3.5 \mu\text{sec}, \pm 0.5 \mu\text{sec}$
- $t_d = 5.0 \mu\text{sec}, \pm 22\%$
- $V_{sag} \leq 120$ volt peak (maximum)
- $t_{sag} \leq 20 \mu\text{sec}$

Measured across a 5.0 ohm non-inductive resistor.

Figure 9 : MIL-STD-461 F CS106 pulse shape

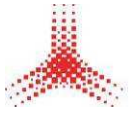

The proposed additional equipment required for CS106 tests comprises:

Pos.	Item	Qty
7	CS106 option	
7.1	Montena M-CS106 Module for MIL-STD 461 F CS106, to be inserted in POG-CS116 generator	1
7.1	Montena IC10M Injection probe for MIL STD 461 CS106, aperture 34 x 43 mm	1
7.3	Montena R5-20A Precision resistor 5 ohm form MIL STD 461, CS106 calibration setup	1
7.4	Differential voltage probe	1
7.5	Montena control software package for CS106	1

5. Control interface for fully automated system

The remote control can be carried out through the RS 232, USB interface of the generator.

The CS 114 + 115 + 116 test setup from montena is supplied with a dedicated control software applications with graphical user interface as shown below.

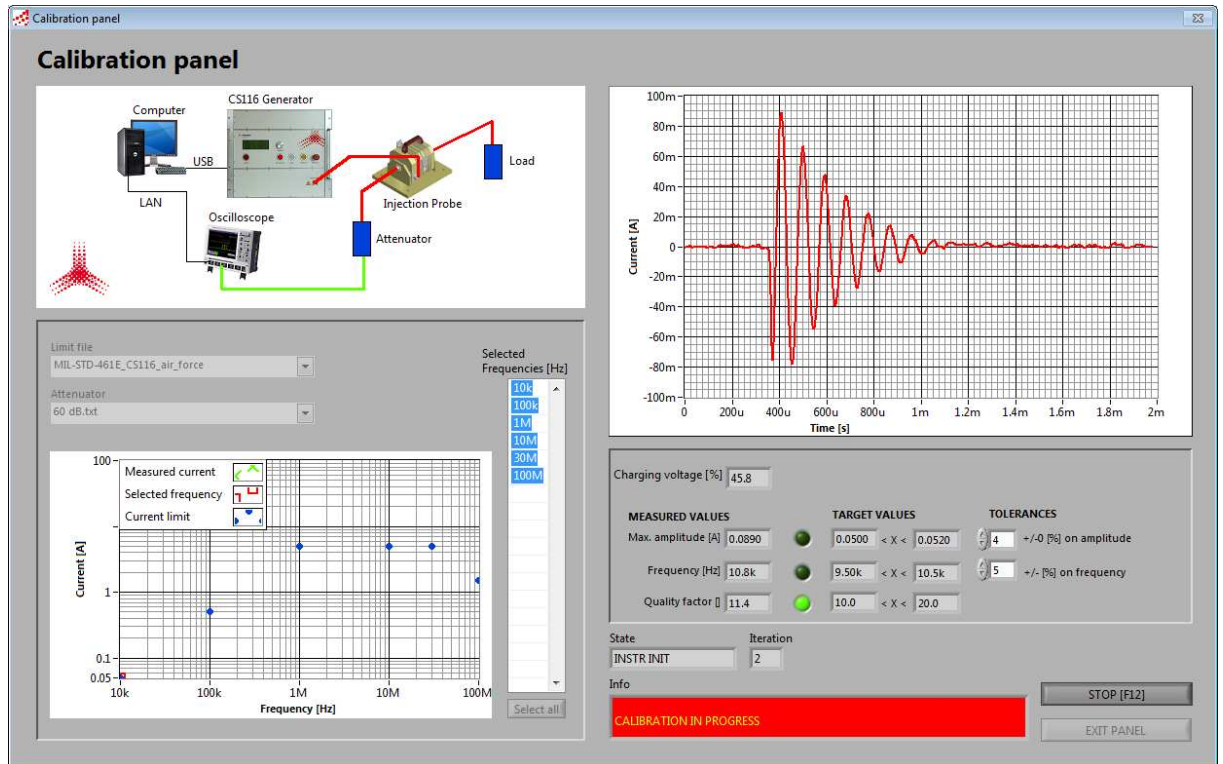
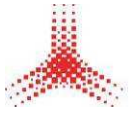

Figure 10 : CS116 control software

This control software comprises:

- A **main** panel to select the desired tests to be performed;
- A **calibration** panel allowing a fully automated calibration of the system;
- A **measurement** panel allowing a fully automated measurement phase with sequential injection of the defined current level for each selected test standard and at each available discrete frequency;
- A **report generation** to keep track of measurements as well as of calibrations.



Calibration panel main features

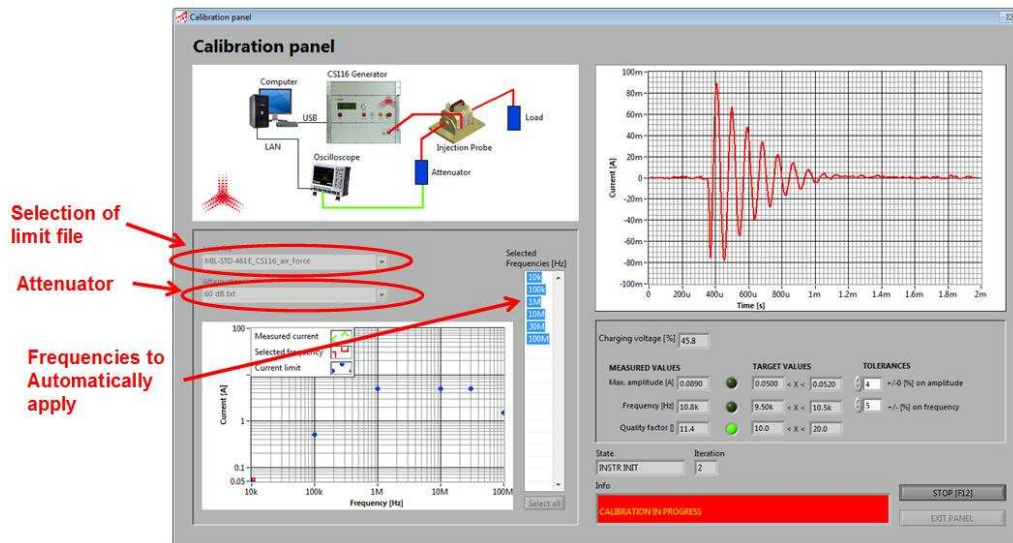
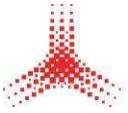

Figure 11 : Calibration panel main features

In order to ease the system calibration procedure, the control software provides:

- A selection of the standard to apply (limit files);
- An integration of the measurement correction factors (attenuators);
- A selection of the frequencies to be applied;
- Automatic calibration procedure (jump to next frequency -> slowly increase the generator loading voltage until the desired injected current level is obtained -> record generator setting -> jump to next frequency ->);
- Automatic configuration of the oscilloscope to get the optimal measurement & display parameters;
- Display of the injected pulses;
- Automatic edition of a system calibration report.



Measurement panel main features

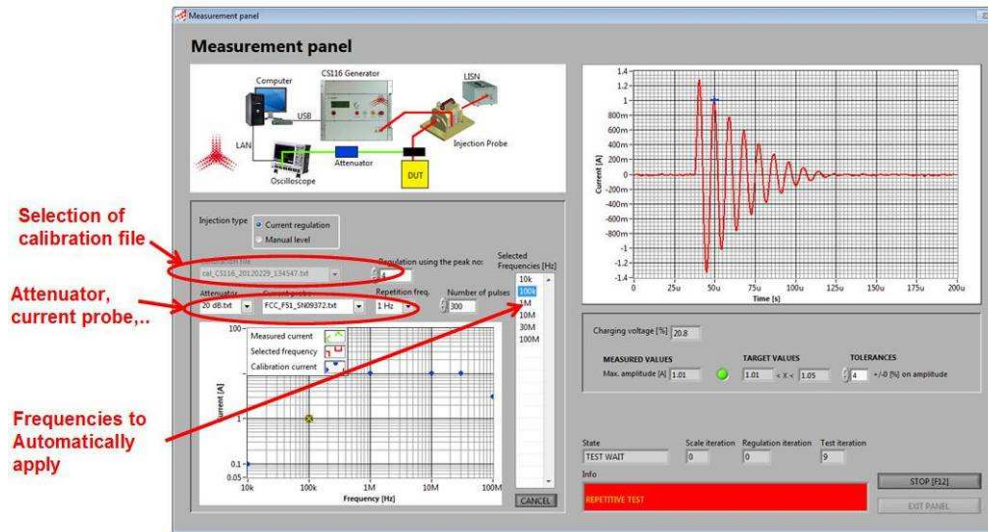
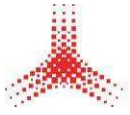

Figure 12 : Measurement panel main features

In order to ease the test measurement procedure, the control software provides:

- A selection of the values to be applied (a calibration file);
- An integration of the measurement correction factors (attenuators and current probe,..);
- A selection of the frequencies to be applied;
- Automatic measurement procedure (jump to next frequency -> slowly increase the generator loading voltage until the desired injected current level is obtained -> record generator setting -> jump to next frequency -> ...), this with the possibility to setup a overall maximal injected current level;
- Automatic configuration of the oscilloscope to get the optimal measurement & display parameters;
- Display of the injected pulses;
- A test report generation.



TEST PROCEDURE SUMMARY

With montena test setup with automation software, the user only has to :

1. Build the calibration setup as displayed in the schematic displayed on the calibration panel
2. Select the standard to apply (i.e. MIL STD 461F, CS116)
3. Select attenuators factors (i.e. ATT_30dB_xxxxx.txt)
4. Automatically calibrate all test frequencies

Press once "Start Calibration"

5. Generate the calibration report
6. Build the test setup as displayed in the software schematic displayed on the measurement panel
7. Select the standard to apply (i.e. Cal_CS116_01_Jan_2010.txt)
8. Select the probes and attenuators factors (i.e. FCC_F51_SNxxxxx.txt)
9. Apply all test frequencies automatically

Press once "Start Measurement"

10. Generate the test report

- ✓ **NO need to exchange injection probe for the different frequencies or between each test setup**
- ✓ **NO need to reconnect generator output cable for each test frequency or each test setup**
- ✓ **NO need to exchange frequency modules for each test frequency**
- ✓ **Automatic calibration at all frequencies**
- ✓ **Application of all test frequencies automatically, level can be selected or automatic**
- ✓ **NO need to configure the oscilloscope**
- ✓ **NO need to manually apply the transfer function of the current probes and attenuators**
- ✓ **Generation of test reports, NO need to record all values read from the oscilloscope**
- ✓ **Generation of calibration reports, NO need to record all calibration setting parameters**

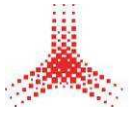

6. Accessories

6.1 Injection probes with calibration jig

One injection probe is required for the CS114, CS115 and CS116 tests. For the system calibration phase, the current injection probe is calibrated with help of a calibration jig, an attenuator and a 50 ohm termination load.

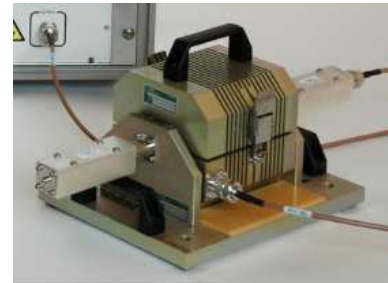

A second injection probe is needed for the CS106 test.



6.2 LISN

The LISN (Line Impedance Stabilisation Network) are used to provide standardised impedance in common mode to the power lines connected to the EUT. This allows a better reproducibility of the tests.

The LISN50-25 fulfils the MIL-STD 461 D,E and F requirements

- 50 Ω // 50 μ H
- 1 x 25 A
- 230 Vac (50/60 Hz) - 115 Vac (400 Hz)



7. Services

7.1 Onsite installation and training

Montena provides onsite installation and training performed by either an engineer from montena or by a local authorized representative support engineer.

A training session is usually given directly after installation. This training includes both the test system operation and maintenance.

7.2 Maintenance

No periodical maintenance is required other than a calibration of the measurement equipment.

On customer request montena can offer this calibration service with support of montena's authorized local representative.

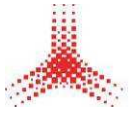

8. Technical specifications

Technical specifications of the CS116 pulse generator

Type	POG-CS116-6	POG-CS116-9	POG-CS116-17
Frequencies	10, 100 kHz 1, 10, 30, 100 MHz	10, 30, 100, 300 kHz 1, 3, 10, 30, 100 MHz	10, 18, 30, 56, 100, 180, 300, 560 kHz 1, 1.8, 3, 5.6, 10, 18, 30, 56, 100 MHz
Standard	MIL-STD 461 D / E / F CS116		
Output current	10 A on 100 ohm (depends on the frequency)		
Output impedance	< 100 ohm		
Damping factor	15 +/- 5		
Repetition rates	single, 0.5 Hz, 1 Hz		
Power rating	210 - 250 V _{ac} / 50 - 60 Hz / 35 W / 75 VA		
Generator weight	21 - 23 kg		
Dimensions	53 x 53 x 45 cm (L x W x H)		

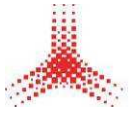

9. Montena

Montena has been incorporated in 1903 as capacitor manufacturing company.

In 1978, the montena EMC division was created to address the arising EMC related problems. Since then montena has earned a worldwide reputation for its leading-edge skills in the fields of high voltage, high frequency and electromagnetic fields. Montena can count on highly specialized know-how in the field of the electromagnetic compatibility. These skills are put to good use in the development and construction of various kinds of equipment, especially EMC test equipment and fast electrical pulse generator.

Montena designs, builds and markets equipment and accessories for EMC tests. The range of products includes antennas, TEM cells, striplines, field sensors, all kind of pulse generators, test benches, etc.

Montena's high voltage pulse generators are mainly used for EMC tests, high speed imaging and pulsed light decontamination. Montena also builds pulse generators according the custom specific needs.

The list below shows some references of test systems according to MIL STD 461, MIL STD 188-125 and other military standards.



Indoor NEMP test system according to MIL STD 461E - RS105
Marx pulse generator 120 kV, rise time 2.3 ns / duration 23 ns
with 2.7 m high radiation line



Large outdoor NEMP test radiation for tests according to MIL STD 461E - RS105
Marx pulse generator 800 kV, rise time 2.3 ns / duration 23 ns
with 9 m high radiation line



Marx pulse generator 350 kV, rise time 5 ns / duration 500 ns with control unit
for Pulse Current Injection according to MIL STD 188/125, short pulse



Damped Sinusoidal pulse generator
for immunity test according to MIL STD 461 / CS116



HIRA antenna
Half impulse radiating antenna for the generation UWB E-field pulses (Ultra Wide Band pulses with sub nanosecond pulse duration)



ESD 300kV and P-static test system for helicopter and airborne systems

